

ANSI

- Construction as per BS5351 and EN ISO 17292
- Flanges ASME B16.5
- Face to Face as per ANSI B16.10 and API 6D
- Top flange ISO 5211
- Rating: 150, 300 and 600 lbs

Applications

- Media with high temperature.
- Media with solids in suspension which produce erosion or damage on valves with soft seats .
- Adapted for highly corrosive products.

Seats and balls

- (Cr-Carbide)
The metallic seat and ball have a projection of Chromium Carbide on AISI 316 with good resistance to the erosion, cavitation and corrosion with a superficial hardness of 950-1100 HVN₃₀₀ , it can support temperatures up to 600°C.

DIN

- Construction DIN 3357 and ISO 17292
- Flanges EN 1092
- Face to Face as per EN 558-1 and DIN 3202
- Top flange ISO 5211
- Rating: PN 16, 40 and 100



Standard construction materials

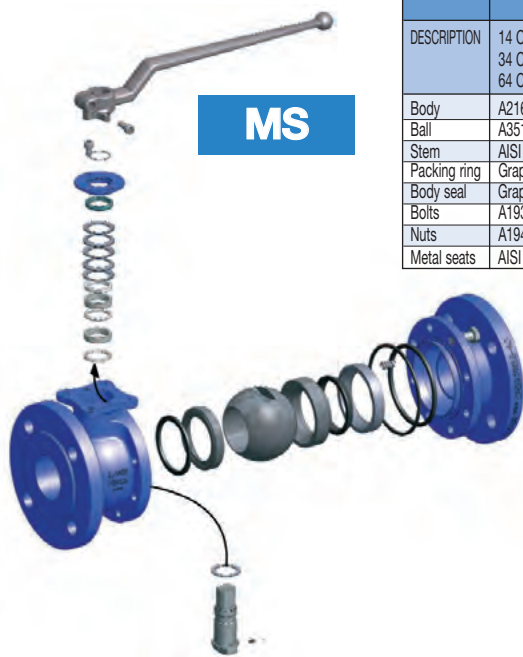

MS

DESCRIPTION	ANSI		DIN	
	14 CGGG 34 CGGG 64 CGGG	16 CGGG 36 CGGG 66 CGGG	04 CGGG 24 CGGG	06 CGGG 26 CGGG
Body	A216 WCC/A105	A351 CF8M	1.0619/A 105	1.4408/AISI316
Ball	A351 CF8M+Cr-C	A351 CF8M+Cr-C	1.4408+Cr-C	1.4408+Cr-C
Stem	AISI 316 / F51	AISI 316 / F51	AISI 316/ F51	AISI 316/ F51
Packing ring	Graphite	Graphite	Graphite	Graphite
Body seal	Graphite	Graphite	Graphite	Graphite
Bolts	A193 B7M	A193 B8M	A193 B7M	A193 B8M
Nuts	A194 2HM	A194 8M	A194 2HM	A194 8M
Metal seats	AISI 316+Cr-C	AISI 316+Cr-C	1.4401 +Cr-C	1.4401+Cr-C

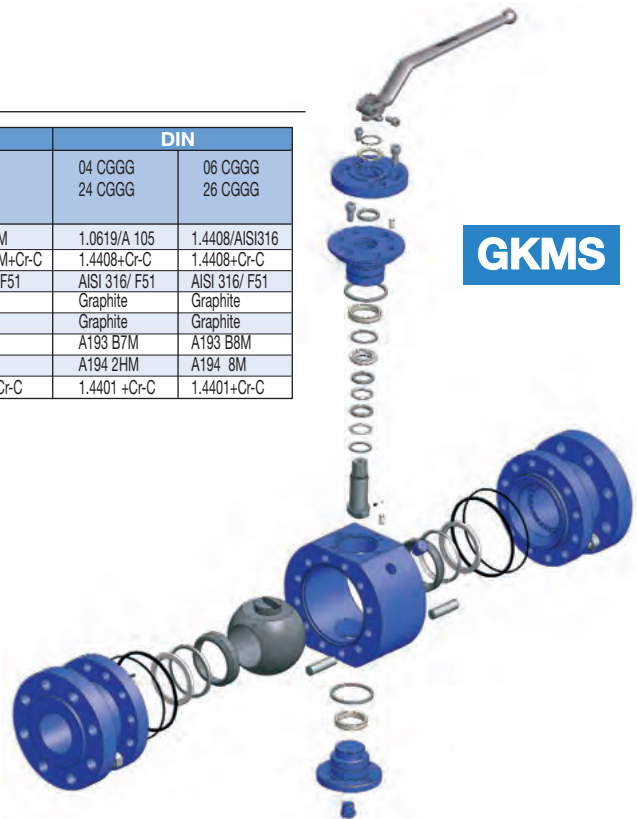

GKMS

Coating and grinding

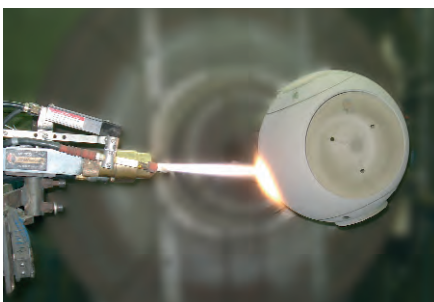

Cr-Carbide Application



Grinding

■ Dimensions

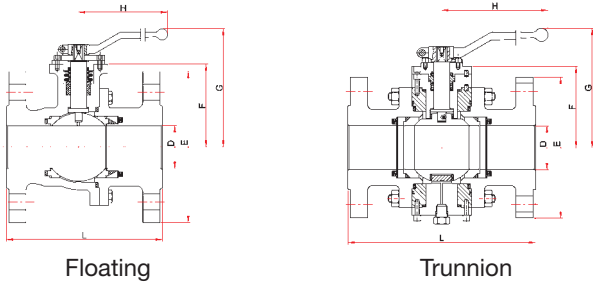

■ Optional ends

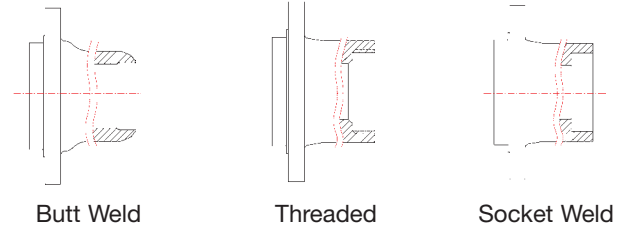

DN=D		DIN										H
F1	F4	F5 (*)	PN16	PN40	PN100	PN16/40	PN100	PN16/40	PN100	G		
15	130	115	-	95	95	-	52	-	100	-	185	
20	150	120	-	105	105	-	54	-	102	-	185	
25	160	125	-	115	115	140	60	61	111	112	185	
32	180	130	-	140	140	-	65	-	115	-	185	
40	200	140	-	150	150	170	75	76	130	130	300	
50	230	150	-	165	165	195	83	83	138	137	300	
65	290	170	-	185	185	220	96	98	150	176	300	
80	310	180	-	200	200	230	114	116	187	215	350	
100	350	190	-	220	235	265	128	141	201	240	350	
125	-	-	325/400	250	270	315	158	189	247	274	680	
150	-	-	350/480	285	300	355	175	237	264	308	680	
200	-	-	400/600	340	375	430	245	281	334	-	750	
250	-	-	450/730	405	450	505	316	316	-	-	-	
300	-	-	500/850	460	515	585	367	370	-	-	-	

NPS		D		L			E			F		G		H
		150 lbs	300 lbs	600 lbs	150 lbs	300 lbs	600 lbs	150/300lbs	600 lbs	150/300lbs	600 lbs			
1/2"	15	108	140	-	89	95	-	52	-	100	-	185		
3/4"	20	117	152	-	98	117	-	54	-	102	-	185		
1"	25	127	165	216	108	124	124	60	61	111	112	185		
1 1/2"	40	165	190	241	127	155	155	75	76	130	130	300		
2"	50	178	216	292	152	165	165	84	83	138	137	300		
2 1/2"	65	190	241	330	178	190	190	96	98	150	176	300		
3"	80	203	283	356	190	209	209	114	116	187	215	350		
4"	100	229	304	432	228	254	273	128	141	201	240	350		
6"	150	394	403	559	279	317	356	175	237	268	308	680		
8"	200	457	502	660	343	381	419	281	281	-	-	-		
10"	250	568	568	787	406	444	508	316	316	-	-	-		
12"	300	610	648	838	482	520	558	380	370	-	-	-		

(*) The second value corresponds to PN 100

Top flange ISO 5211

DN	15	20	25	40	50	65	80	100	150	200	250	300
NPS	1/2"	3/4"	1"	1 1/2"	2"	2 1/2"	3"	4"	6"	8"	10"	12"
PN16-40	F05	F05	F05	F07	F07	F07	F10	F10	F12	F14	F14	F16
PN 100	-	-	F05	F07	F07	F10	F10	F12	F14	F16	F16	F25
150-300 lbs	F05	F05	F05	F07	F07	F07	F10	F10	F12	F14	F14	F16
600 lbs	-	-	F05	F07	F07	F10	F10	F12	F14	F16	F16	F25

Manufacture range

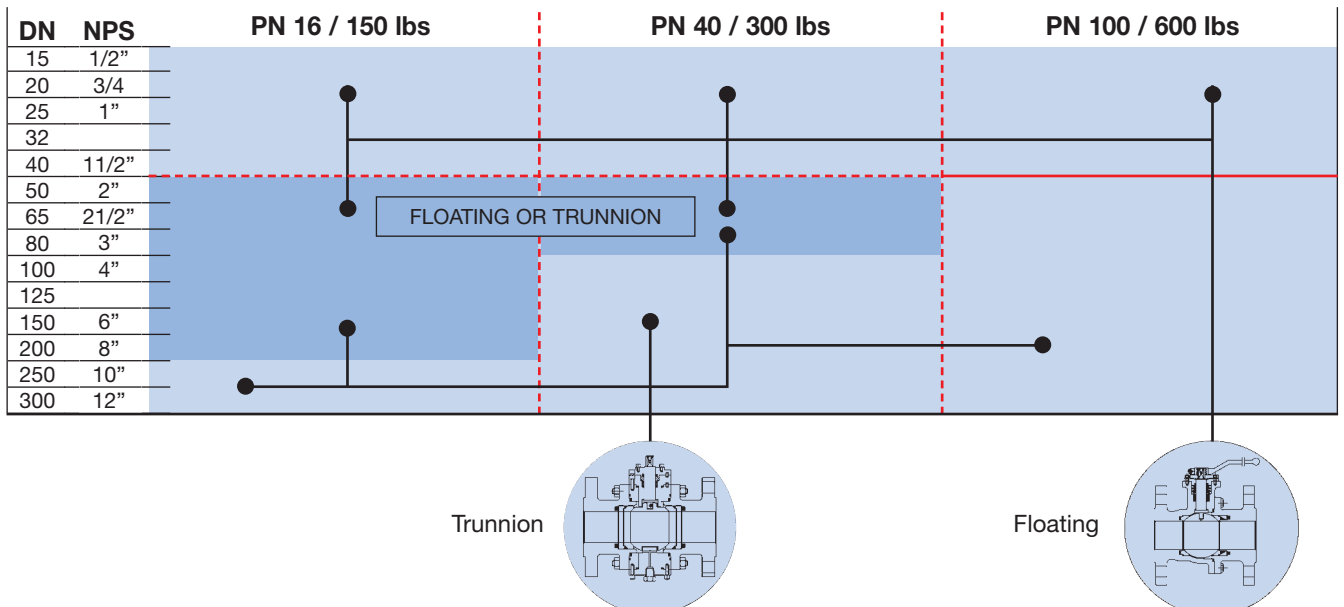

■ Stem extensions

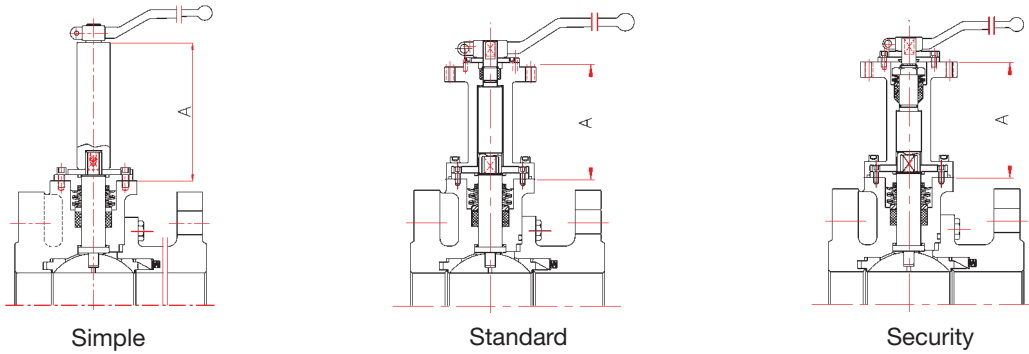

A = 150mm . Other lengths under request.
Recommended for temperatures above 350°C

■ Leak tests

According API 598, ISO 5208 Rate C, EN12266 Rate C, ANSI FCI 70 Class V (on request class VI or leakage 0).

Class	Hydraulic shell test	Hydraulic seat test	Pneumatic seat test	Size	Shell test Test Duración minimum	Seat test	
						Test duration minimum	Maximum leakage rate as per class V (ml / min.)
150 Lbs/PN 16	30/24 bar	22/18 bar	6 bars	1/2" to 1 1/2" (DN15-40)	15 sec	15 sec	0.2-0.3
300 Lbs/PN 40	78/60 bar	57/44 bar	6 bars	2" to 6" (DN50-150)	60 sec	60 sec	1.2-3.3
600 Lbs/PN 100	156/150 bar	114/110 bar	6 bars	8" (DN 200)	120 sec	120 sec	9
				10" to 12" (DN250-300)	180 sec	120 sec	11.3-13.5

■ Breakaway torque in Nm*

DN	15	20	25	40	50	65	80	100	150	200	250	300
NPS	1/2"	3/4"	1"	1 1/2"	2"	2 1/2"	3"	4"	6"	8"	10"	12"
150Lbs	11	14	20	60	70	110	180	280	539	910	1560	2190
300Lbs	18	21	28	70	118	170	310	510	890	1530	2020	2430
600Lbs	-	-	50	92	170	-	440	810	1580	2645	3413	5120
PN16	10	12	18	55	58	105	175	260	520	715	1145	1950
PN40	17	20	25	65	85	130	275	420	700	1230	1950	2250
PN100	-	-	50	92	170	275	440	810	1580	2645	3413	5120

* Breakaway to ΔP maximum for for each rating .Test made with water at ambient Temperature, excluding safety factor.

■ P-T Diagram

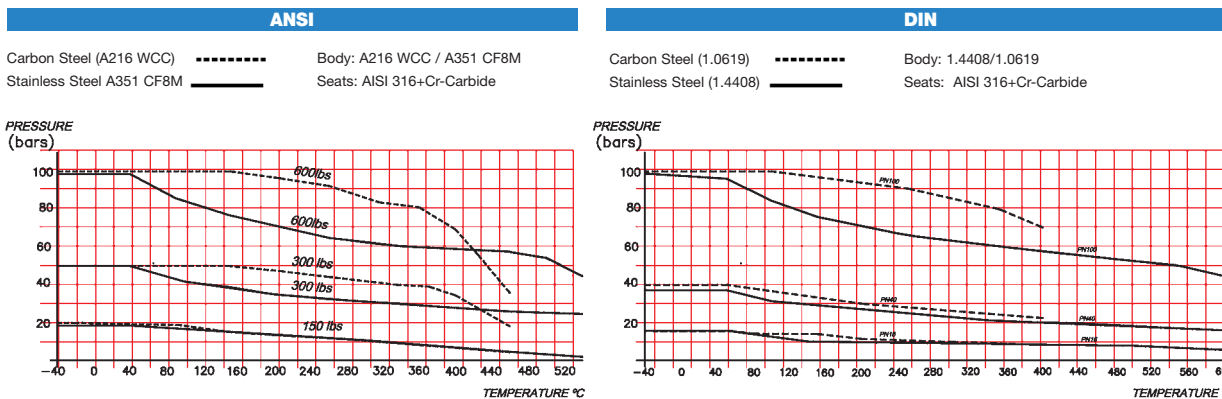

Pekos Valves S.A.

C/ Rec del Molinar, 9 - Poligono Ind. El Circuit
08160 Montmeló - Barcelona (Spain)

Tel. : (+34) 93 579 93 70
Fax. : (+34) 93 579 92 44

pekos@pekos.es
www. pekos.es